



Solid State Relays 45 mm, 3-Phase with Integrated Heatsink Types RGCM3



- 3-pole AC switching solid state contactors
- Product width 45 mm
- Rated operational voltage: up to 660 VAC
- Rated operational current: up to 15.5 AAC
- Control voltages: 5-32 VDC, 20-275 VAC (24-190 VDC)
- Up to 1,800 A²s for I²t
- Certified motor ratings up to 2 HP / 2.2 kW @ 400 VAC
- Integrated varistor protection on output
- Enclosed heatsink
- DIN or panel mount



Product Description

This product is intended to replace mechanical contactors especially when switching is frequent. The product width is 45 mm and the heatsink is enclosed to provide a look alike to its mechanical counterpart. The enclosed heatsink eliminates the need for protective earth connection.

when the voltage crosses zero and switches OFF when the current crosses zero. Apart for resistive and slightly inductive loads, the RGCM is certified for motor switching with associated motor ratings.

Varistors are integrated for overvoltage protection. A green LED gives indication of control voltage presence.

The RGCM switches ON

Specifications are at a surrounding temperature of 25°C unless otherwise specified.

Ordering Key **RGCM 3 A 60 D 15 G K E**

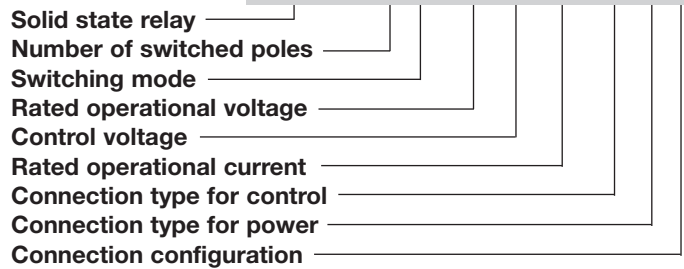

Ordering Key

SSR with heatsink	Rated voltage, Blocking voltage	Control voltage	Rated current/pole @ 40°C ¹	Connection control	Connection power	Connection configuration
RGCM3A: 3-pole switching, ZC ²	60: 42 - 660 VAC, 1200 Vp	D: 5 - 32 VDC A: 20-275 VAC, 24-190 VDC	15: 15.5 AAC	G: Pluggable box clamp	K: Screw	E: Contactor

1. Refer to Derating Curves
2. ZC = Zero Cross Switching

Selection Guide

Rated output voltage	Control voltage	Connection control	Connection power	Rated operational current @ 40°C (I ² t value) 3-pole switching 15.5 AAC / pole (1800 A ² s)
600 VAC, ZC	5-32 VDC	Box clamp	Screw	RGCM3A60D15GKE
	20-275 VAC, 24-190 VDC	Box clamp	Screw	RGCM3A60A15GKE

General Specifications

Latching voltage (across L-T)	≤ 20 V	Pollution degree	2 (non-conductive pollution with possibilities of condensation)
Operational frequency range	45 to 65 Hz	Over-voltage category	III (fixed installations)
Power factor	> 0.5 @ Vrated	Isolation	
Touch protection	IP20	Input to Output	4000 Vrms
Control input status	continuously ON Green LED, when control input is applied	Input & Output to Case	4000 Vrms

Output Voltage Specifications

Operational voltage range	42-600 VAC, +10% -15% on max
Blocking voltage	1200 Vp
Internal varistor	625 V

Output Specifications

Rated operational current ³ AC-51 rating @ Ta=25°C	18 AAC
AC-51 rating @ Ta=40°C	15.5 AAC
AC-53a rating @ Ta=40°C	5.8 AAC
Number of motor starts (I _n /I _e =6, T _n =6, T _{ON} /T _{ON} + T _x = 50%) at 40°C ⁴	30
Minimum operational current	250 mAAC
Rep. overload current - (Motor Rating) PF = 0.4 - 0.5 UL508: T _{AMB} =40°C, t _{ON} =1 s, t _{OFF} =9 s, 50 cycles	40 AAC
Maximum transient surge current (I _{TSM}), t=10 ms	600 Ap
I ² t for fusing (t=10 ms)	1800 A ² s
Critical dv/dt (@ T _j init = 40°C)	1000 V/μs

3: Refer to Derating Curves

4: Overload cycle definition: I_n/I_e = overload current factor, T_n = time during inrush current, T_{ON}/T_{ON} + T_x = duty cycle. Refer to Characteristic Curves and Operating Cycles section for other parameters.

Motor Ratings: HP (UL508) / kW (EN/IEC 60947-4-2) @ 40°C

	115 VAC	230 VAC	400 VAC	480 VAC	600 VAC
RGCM3..15	½ HP / 0.37 kW	1 HP / 1.1 kW	2 HP / 2.2 kW	3 HP / 3 kW	3 HP / 4 kW

Input Specifications

	RG..D..	RG..A..
Control voltage range	5 - 32 VDC	20-275 VAC, 24 (-10%) - 190 VDC
Pick-up voltage	4.8 VDC	20 VAC/DC
Drop-out voltage	1 VDC	5 VAC/DC
Maximum reverse voltage	32 VDC	-
Maximum response time	0.5 cycle + 500 μ s @ 24 VDC	2 cycles @ 230 VAC / 110 VDC
Input current @ 40°C	See diagrams below	See diagrams below

RG..D..

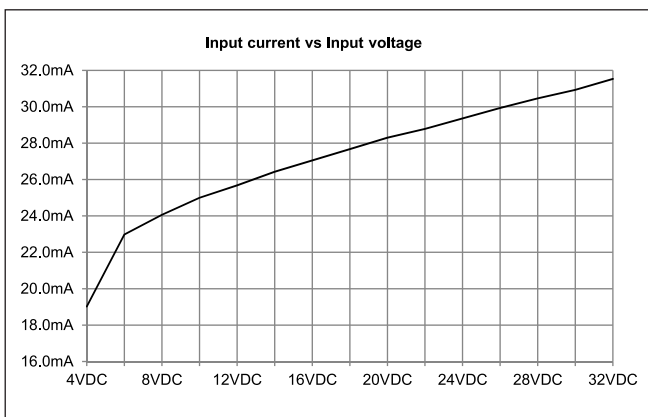

RG..A..

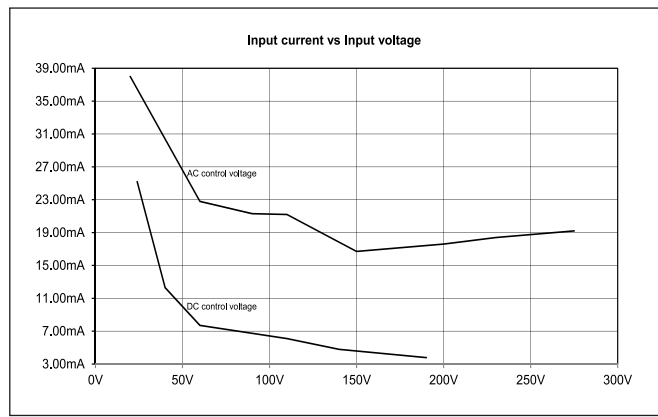

Output Power Dissipation

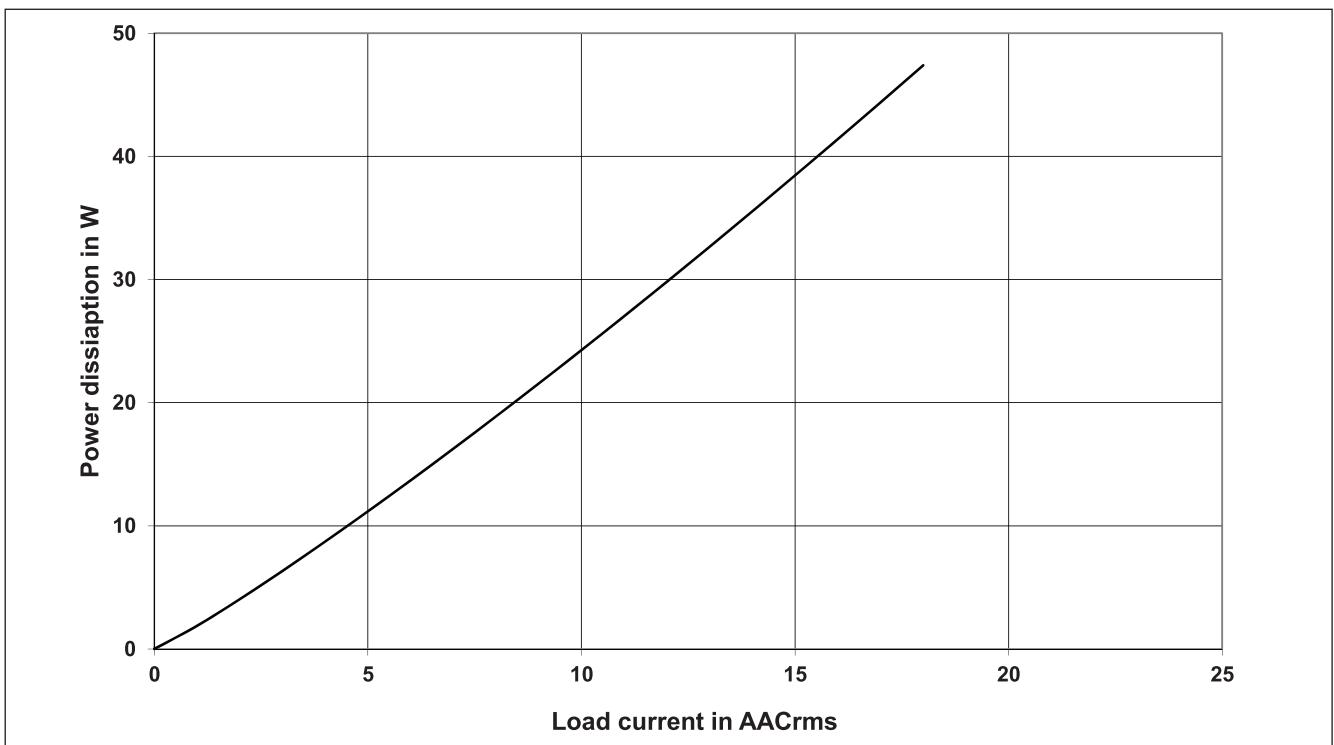

Characteristic Curves and Operating Cycles

Maximum allowable number of starts depending on the T_n and T_{ON}

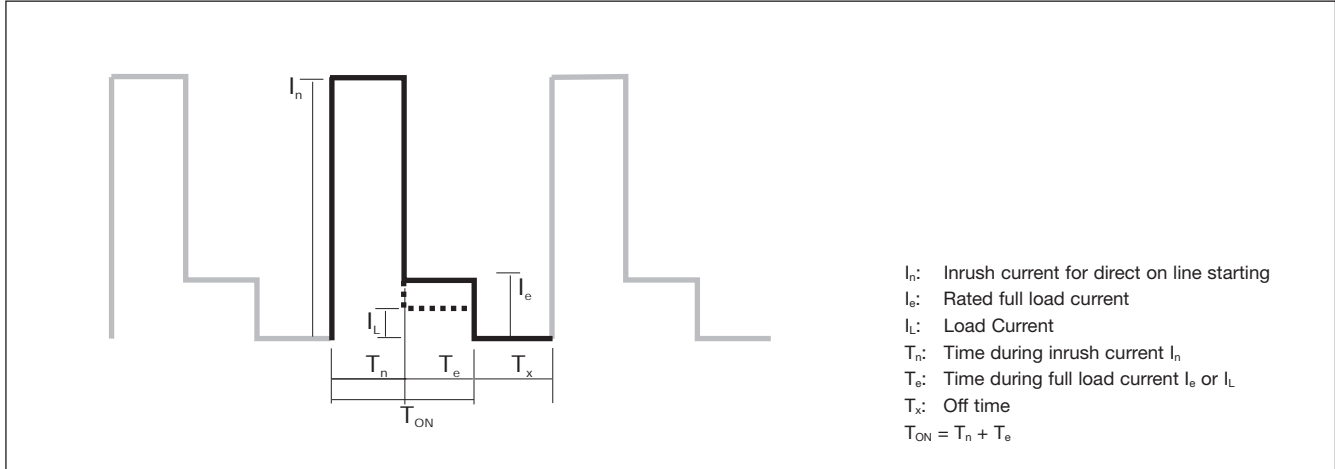

Curves: No. of switching cycles per hour versus T_{ON}

Chart No. 1

$$\frac{I_n}{I_e} = 7.2, \frac{I_L}{I_e} = 1$$

T_{ON} (s)	Number of Switches per Hour						
	$T_n = 0.05s$	$T_n = 0.1s$	$T_n = 0.2s$	$T_n = 0.4s$	$T_n = 0.8s$	$T_n = 1.6s$	$T_n = 3.2s$
0.1	1800	910	-	-	-	-	-
1	1500	800	420	220	102	-	-
10	280	300	25	160	90	40	15
100	38	38	38	35	35	25	6
1000	-	-	-	-	-	-	-

Chart No. 2

$$\frac{I_n}{I_e} = 7.2, \frac{I_L}{I_e} = 0.6$$

T_{ON} (s)	Number of Switches per Hour						
	$T_n = 0.05s$	$T_n = 0.1s$	$T_n = 0.2s$	$T_n = 0.4s$	$T_n = 0.8s$	$T_n = 1.6s$	$T_n = 3.2s$
0.1	1900	900	-	-	-	-	-
1	1800	850	440	120	110	-	-
10	390	390	350	190	100	50	25
100	38	38	38	38	25	25	20
1000	-	-	-	-	-	-	-

Chart No. 3

$$\frac{I_n}{I_e} = 4, \frac{I_L}{I_e} = 1$$

T_{ON} (s)	Number of Switches per Hour						
	$T_n = 0.05s$	$T_n = 0.1s$	$T_n = 0.2s$	$T_n = 0.4s$	$T_n = 0.8s$	$T_n = 1.6s$	$T_n = 3.2s$
0.1	5100	2800	-	-	-	-	-
1	2700	1900	1100	650	350	-	-
10	250	250	250	290	200	140	75
100	36	36	36	36	36	36	30
1000	-	-	-	-	-	-	-

Chart No. 4

$$\frac{I_n}{I_e} = 4, \frac{I_L}{I_e} = 0.6$$

T_{ON} (s)	Number of Switches per Hour						
	$T_n = 0.05s$	$T_n = 0.1s$	$T_n = 0.2s$	$T_n = 0.4s$	$T_n = 0.8s$	$T_n = 1.6s$	$T_n = 3.2s$
0.1	5500	2900	-	-	-	-	-
1	3400	2300	1400	700	350	-	-
10	350	350	350	350	280	170	80
100	36	36	36	36	36	36	36
1000	-	-	-	-	-	-	-

Current Derating (UL508)

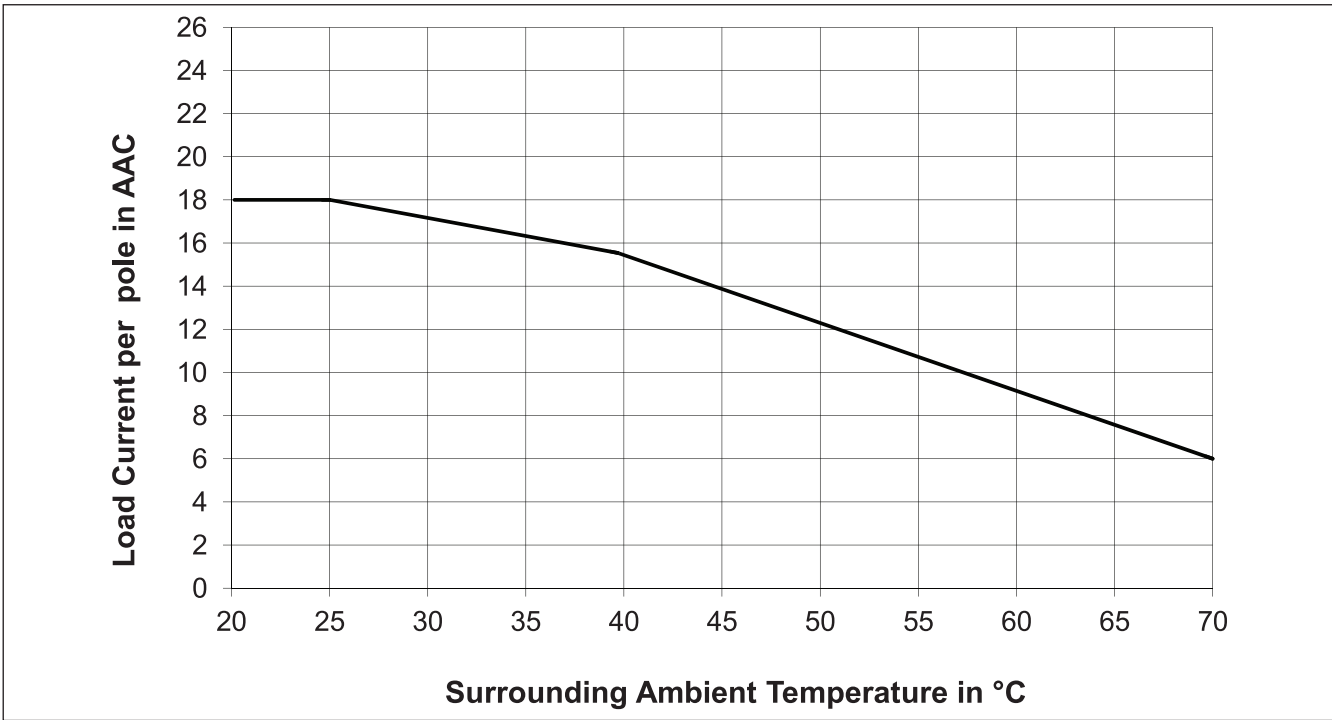

Derating vs. Spacing Curves

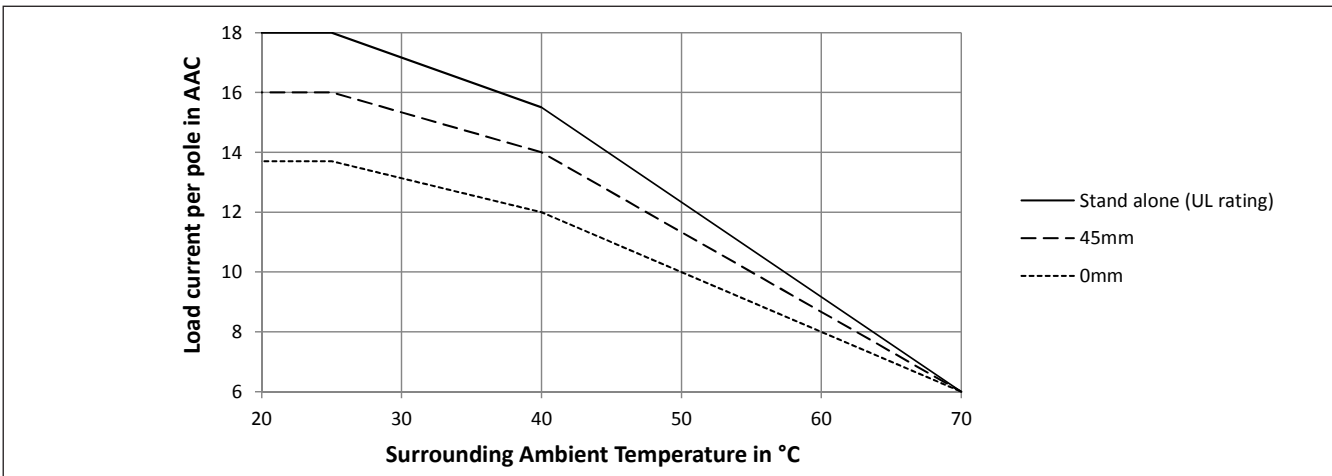

Agency Approvals and Conformances

Conformance

EN/IEC 60947-4-2
EN/IEC 60947-4-3

Agency Approvals

UL Listed (E172877), UL508
cUL Listed (E172877), C22.2 No.14-13





Electromagnetic Compatibility

EMC Immunity	EN 60947-4-3	Radiated Radio Frequency Immunity	EN/IEC 61000-4-3
Electrostatic Discharge (ESD) Immunity	EN/IEC 61000-4-2	10 V/m, 80 - 1000 MHz	Performance Criteria 1
Air discharge, 8 kV	Performance Criteria 2	10 V/m, 1.4 - 2 GHz	Performance Criteria 1
Contact, 4 kV	Performance Criteria 2	3 V/m, 2 - 2.7 GHz	Performance Criteria 1
Electrical Fast Transient (Burst) Immunity	EN/IEC 61000-4-4	Conducted Radio Frequency Immunity	EN/IEC 61000-4-6
Output: 2 kV, 5 kHz	Performance Criteria 1	10 V/m, 0.15 - 80 MHz	Performance Criteria 1
Input: 1 kV, 5 kHz	Performance Criteria 1	Voltage Dips Immunity	EN/IEC 61000-4-11
Electrical Surge Immunity	EN/IEC 61000-4-5	0% for 0.5, 1 cycle	Performance Criteria 2
Output, line to line, 1 kV	Performance Criteria 1	40% for 10 cycles	Performance Criteria 2
Output, line to earth, 2 kV	Performance Criteria 1	70% for 25 cycles	Performance Criteria 2
Input, line to line, 1 kV	Performance Criteria 2	80% for 250 cycles	Performance Criteria 2
Input, line to earth, 2 kV	Performance Criteria 2	Voltage Interruptions Immunity	EN/IEC 61000-4-11
		0% for 5000 ms	Performance Criteria 2
EMC Emission	EN 60947-4-3*	Radio Interference Field Emission (Radiated)	EN/IEC 55011
Radio Interference Voltage Emission (Conducted)	EN/IEC 55011	30 - 1000 MHz	Class A (industrial)
0.15 - 30 MHz	Class A (industrial) with filters - see filter information		

Note:

- Control input lines must be installed together to maintain products' susceptibility to Radio Frequency interference.
- Use of AC solid state relays may, according to the application and the load current, cause conducted radio interferences. Use of main filters may be necessary for cases where the user must meet E.M.C. requirements. The capacitor values given inside the filtering specification tables should be taken only as indications, the filter attenuation will depend on the final application.
- This product has been designed for Class A equipment. Use of this product in domestic environments may cause radio interference, in which case the user may be required to employ additional mitigation methods.
- * For conformance to EN/IEC 61000-6-4, an external capacitor class X1, 220 nF, 275 VAC is to be connected across the input control lines A1-A2.
- Performance Criteria 1 (Performance Criteria A): No degradation of performance or loss of function is allowed when the product is operated as intended.
- Performance Criteria 2 (Performance Criteria B): During the test, degradation of performance or partial loss of function is allowed. However, when the test is complete the product should return operating as intended by itself.
- Performance Criteria 3 (Performance Criteria C): Temporary loss of function is allowed, provided the function can be restored by manual operation of the control.

Filtering - EN / IEC 55011 Class A compliance

Part Number	Suggested filter for compliance	Maximum Heater current
RGCM3A60..15	220 nF / 760 V / X1	20 A

Filter Connection Diagrams

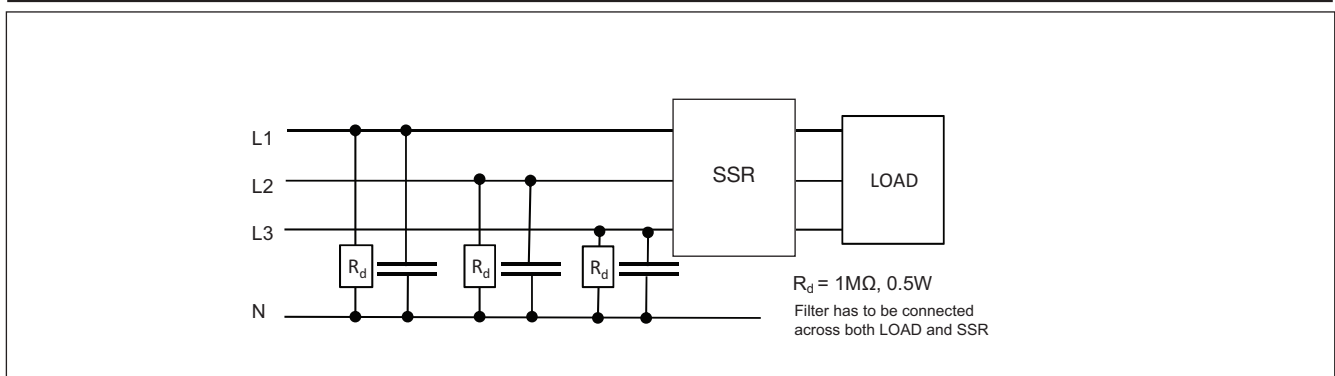

Dimensions

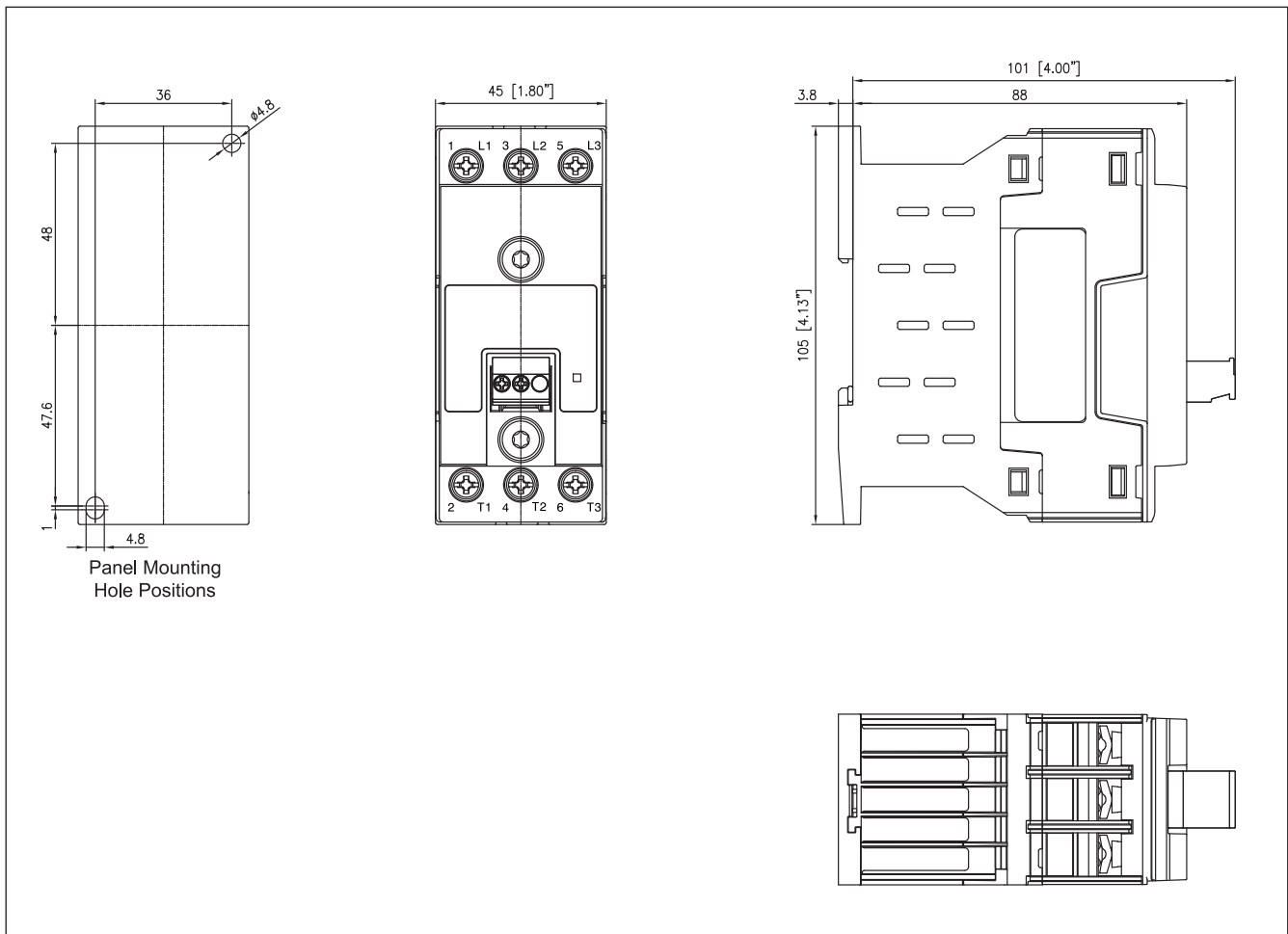

Terminal Layout

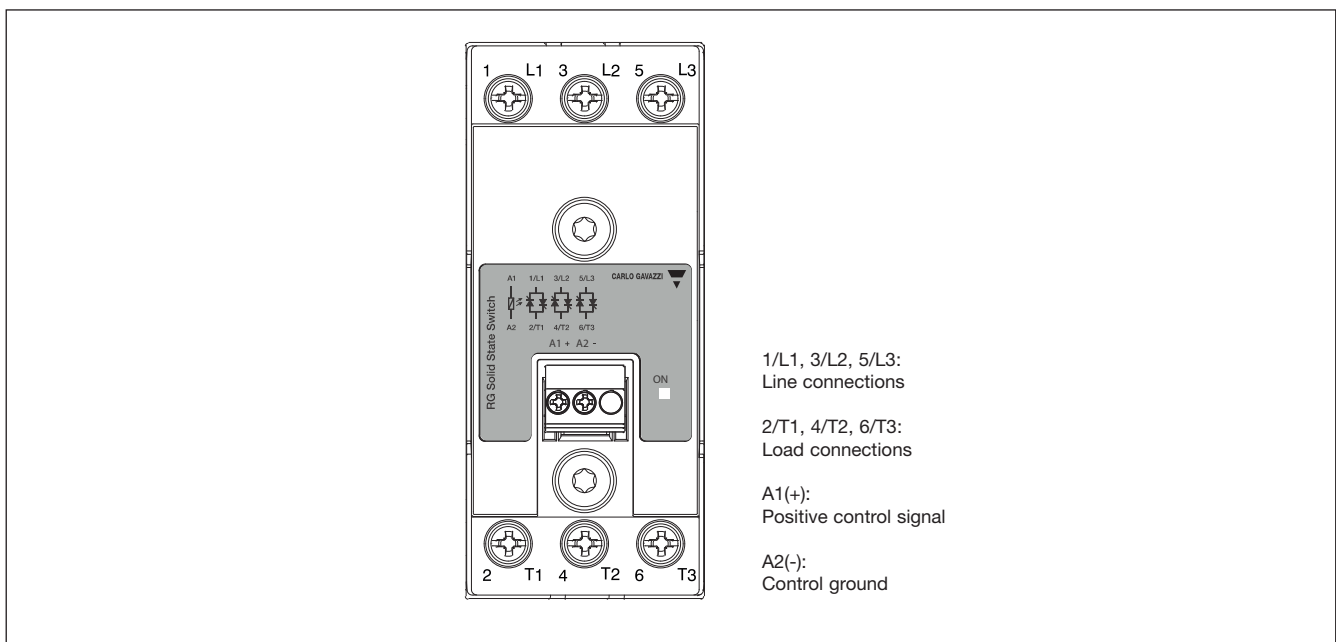

Connection Specifications

POWER CONNECTIONS

Use 75°C copper (Cu) conductors

1/L1, 3/L2, 5/L3, 2/T1, 4/T2, 6/T3

Stripping Length (X)

10 mm

Connection type

M4 screw with captivated washer

Rigid (Solid & Stranded)

UL/ cUL rated data

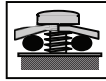
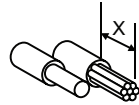

2 x 1.5.. 2.5 mm²
2 x 2.5.. 6.0 mm²
2 x 16.. 14 AWG
2 x 14.. 10 AWG

1 x 1.5.. 6 mm²
1 x 16.. 10AWG

Flexible with end sleeve



2 x 1.5 ... 2.5 mm²
2 x 2.5..6.0 mm²
2 x 16.. 14 AWG
2 x 14.. 10 AWG

1 x 1.5.. 6mm²
1 x 16.. 10AWG

Flexible without end sleeve



2 x 1.5 ... 2.5 mm²
2 x 2.5..6.0 mm²
2 x 16.. 14 AWG
2 x 14.. 10 AWG

1 x 1.5.. 6 mm²
1 x 16.. 10AWG

Torque specifications



2 Nm (17.7 in-lb)
Pozidriv 2

Aperture for termination lug

11 mm

CONTROL CONNECTIONS

Use 60/75°C copper (Cu) conductors

A1(+), A2(-)

Stripping Length (X)

6 - 7.5 mm

Connection type

Pluggable box clamp

Rigid (Solid & Stranded)

UL/cUL rated data

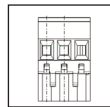
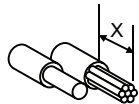

1x 0.2..2.5 mm²
1x 24...12 AWG

Torque Specifications



0.8 Nm (7.0 lb-in),
M3, Philips

Connection Diagram

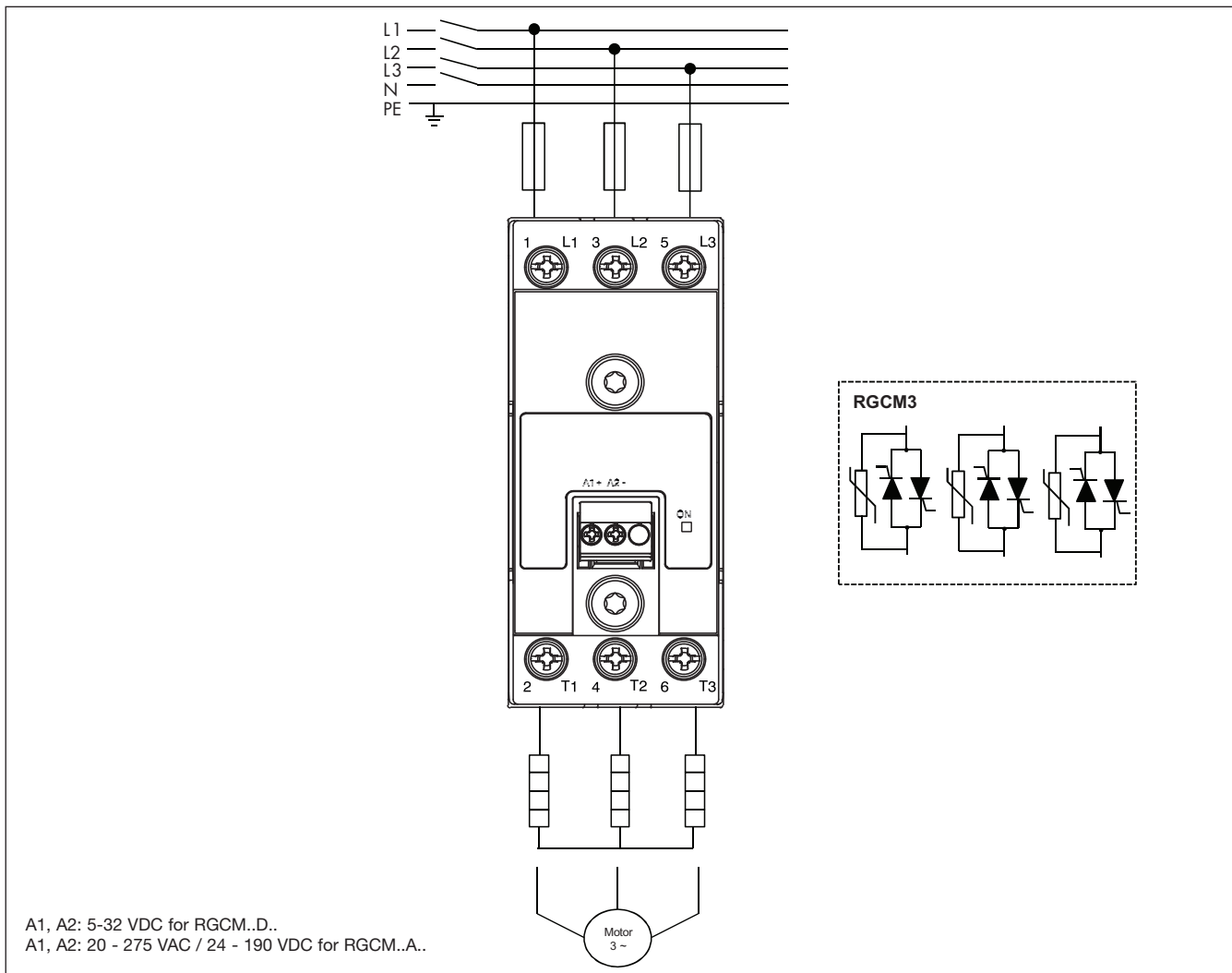

Environmental Specifications

Operating Temperature	-40°C to 70°C (-40°F to +158°F)	Relative humidity	95% non-condensing @ 40°C
Storage Temperature	-40°C to 100°C (-40°F to +212°F)	UL flammability rating (housing)	UL 94 V0
EU RoHS compliant	Yes	Installation Altitude	0 - 1000 m. Above 1000 m derate linearly by 1% of FLC per 100 m up to a maximum of 2000 m
China RoHS compliant	Refer to Environmental Information (page 12)	Weight	400 g
Impact resistance (EN50155, EN61373)	15/11 g/ms		
Vibration resistance (2-100Hz, IEC60068-2-6, EN50155, EN61373)	2 g per axis		

Installation Instructions

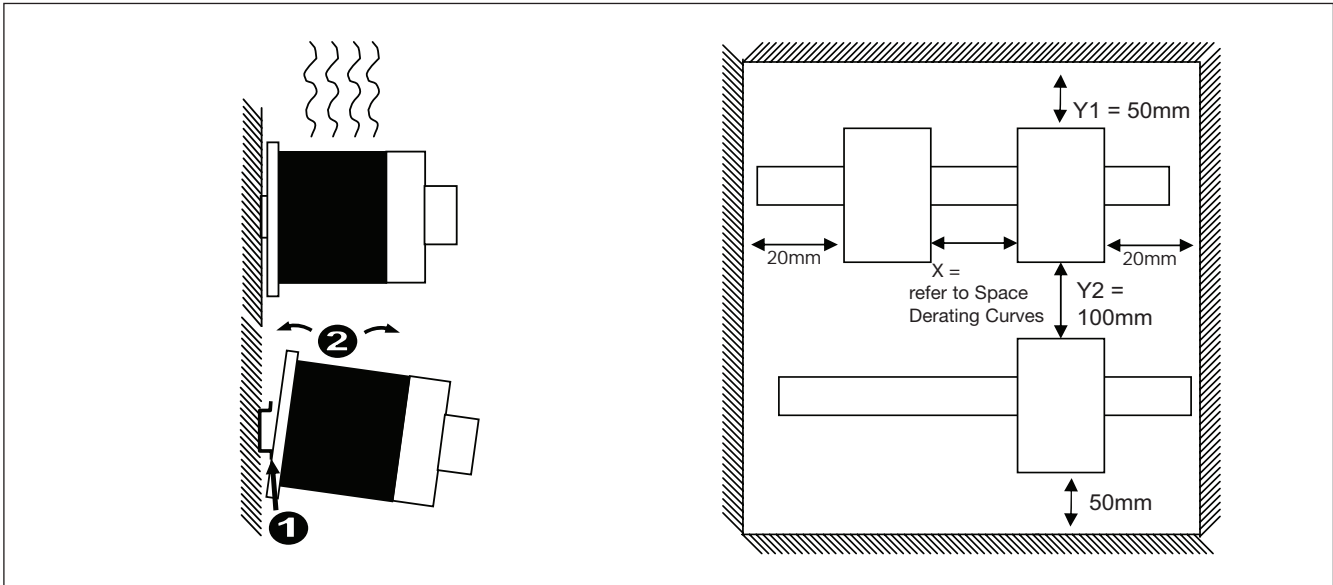

1. Push spring upwards against DIN rail. When spring is under pressure, clip device on to the DIN rail
2. Push spring upwards against DIN rail. When spring is under pressure, remove device from DIN rail
3. Mount the cooling fins vertically

Short Circuit Protection

Protection Co-ordination, Type 1 vs Type 2:

Type 1 protection implies that after a short circuit, the device under test will no longer be in a functioning state. In type 2 co-ordination the device under test will still be functional after the short circuit. In both cases, however the short circuit has to be interrupted. The fuse between enclosure and supply shall not open. The door or cover of the enclosure shall not be blown open. There shall be no damage to conductors or terminals and the conductors shall not separate from terminals. There shall be no breakage or cracking of insulating bases to the extent that the integrity of the mounting of live parts is impaired. Discharge of parts or any risk of fire shall not occur.

The product variants listed in the table hereunder are suitable for use on a circuit capable of delivering not more than 5,000A rms Symmetrical Amperes, 600 Volts maximum when protected by fuses. Tests at 5,000A were performed with Class RK5 fuses; please refer to table below for maximum allowed ampere rating of the fuse. Use fuses only.

Tests with class RK5 fuses represent class CC fuses.

Co-ordination type 1 (UL508)

Part No.	Max. fuse size [A]	Class	Short circuit current [kArms]	Voltage [VAC]
RGCM3..15	25 25	RK5 CC	5	Max. 600

Co-ordination type 2 (EN/IEC 60947-4-2/-4-3)

Part No.	Ferraz Shawmut		Short circuit current [kArms]	Voltage [VAC]
	Fuse size [A]	Part Number		
RGCM3..15	25	6.9xx CP gRC 14x51/25	5	Max. 600

Type 2 Protection with Miniature Circuit Breakers

Solid State Relay type	ABB Model no. for Z - type M. C. B. (rated current)	ABB Model no. for B - type M. C. B. (rated current)	Wire cross sectional area [mm ²]	Minimum length of Cu wire conductor [m] ⁵
RGCM3..15	S201 - Z10 (10 A)	S201-B4 (4 A)	1.0	7.6
			1.5	11.4
			2.5	19.0
	S201 - Z16 (16 A)	S201-B6 (6 A)	1.0	5.2
			1.5	7.8
			2.5	13.0
			4.0	20.8
	S201 - Z20 (20 A)	S201-B10 (10 A)	1.5	12.6
			2.5	21.0
	S201 - Z25 (25 A)	S201-B13 (13 A)	2.5	25.0
			4.0	40.0

5: Between MCB and Load (including return path which goes back to the mains if applicable).

Note: A prospective current of 6 kA and a 230/400 V power supply system is assumed for the above suggested specifications. For cables with different cross section than those mentioned above please consult Carlo Gavazzi's Technical Support Group.



Environmental Information

The declaration in this section is prepared in compliance with People's Republic of China Electronic Industry Standard SJ/T11364-2014: Marking for the Restricted Use of Hazardous Substances in Electronic and Electrical Products.

Part Name	Toxic or Harardous Substances and Elements					
	Lead (Pb)	Mercury (Hg)	Cadmium (Cd)	Hexavalent Chromium (Cr(VI))	Polybrominated biphenyls (PBB)	Polybrominated diphenyl ethers (PBDE)
Power Unit Assembly	x	○	○	○	○	○

O: Indicates that said hazardous substance contained in homogeneous materials for this part are below the limit requirement of GB/T 26572.
 X: Indicates that said hazardous substance contained in one of the homogeneous materials used for this part is above the limit requirement of GB/T 26572.

环境特性

这份申明根据中华人民共和国电子工业标准 SJ/T11364-2014：标注在电子电气产品中限定使用的有害物质

零件名称	有毒或有害物质与元素					
	铅 (Pb)	汞 (Hg)	镉 (Cd)	六价铬 (Cr(VI))	多溴化联苯 (PBB)	多溴联苯醚 (PBDE)
功率单元	x	○	○	○	○	○

O:此零件所有材料中含有的该有害物低于GB/T 26572的限定。
 X: 此零件某种材料中含有的该有害物高于GB/T 26572的限定。



Accessories

Motor Overload Relay Adaptor

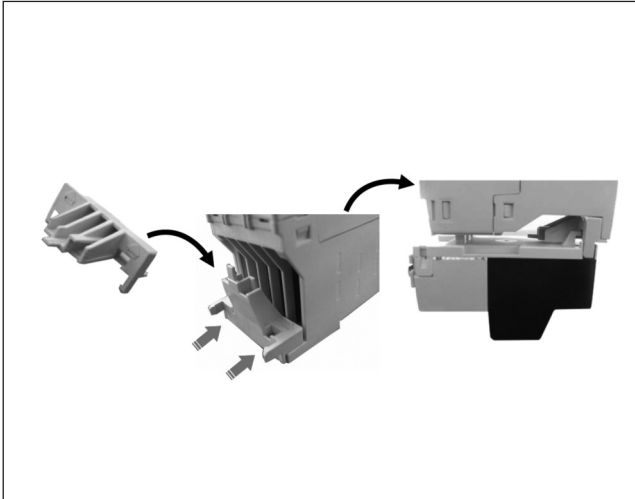

Ordering Key

Overload relay adaptor

REC3ADAPTOR

This plastic adaptor can be fitted to the RGCM housing cover to facilitate mounting of overload protection relays. This adaptor is compatible with:

Manufacturer	Series	Example
ABB	TA	TA25DU-8.5
Siemens	3RU11	3RU1126-1FB0

REC3ADAPTOR packing quantity is 5 pcs.

Control Plugs

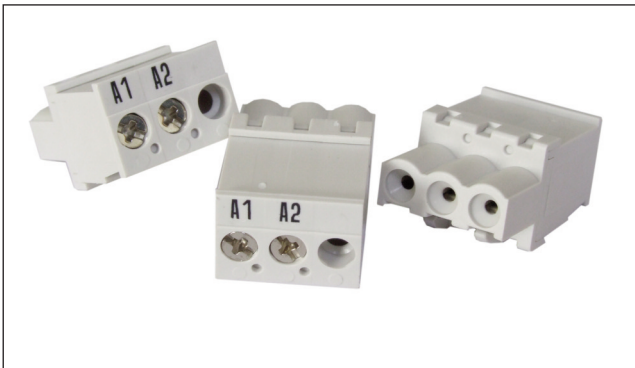

Ordering Key

Pack of 10 box clamp control plugs

RG3G25

* Refer to 'Connection Specifications' section for further details.